

PRZED ROZPOCZĘCIEM MONTAŻU ZAPOZNAĆ SIĘ Z INSTRUKCJĄ

Narzędzia niezbędne do montażu (nie dostarczone przez producenta)

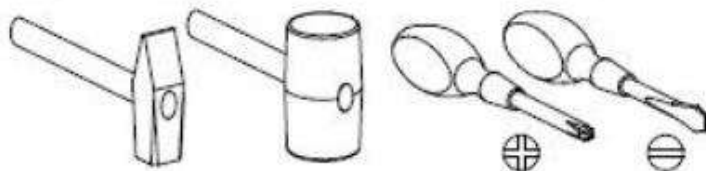
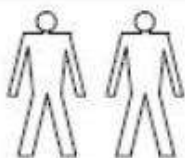
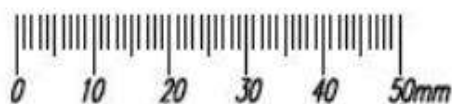

# VIGO

## Witryna

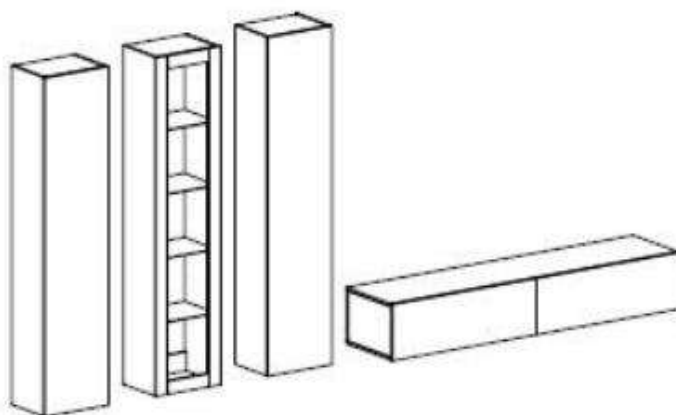
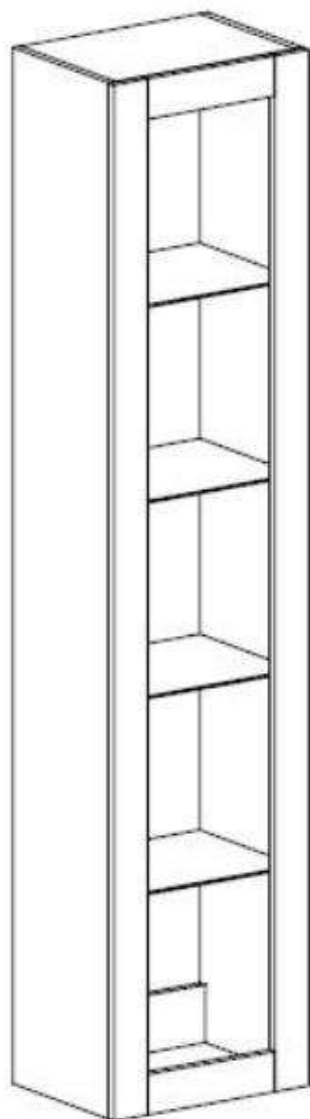



G21  3 x 16 x12

I2  x12

F2  x16

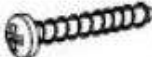
G31  3 x 12 x2

G30  3 x 20 x2

W4  x45

C3  Z35PR x4

L9  x1

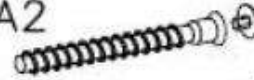
A2   $\varnothing 7 \times 70$  x4

D3  PZ35PR x4

U8  x4

K5  x12

K1   $\varnothing 15 \times 12$  x12

B1  x12

W2  x1

G5  4 x 13 x8

I

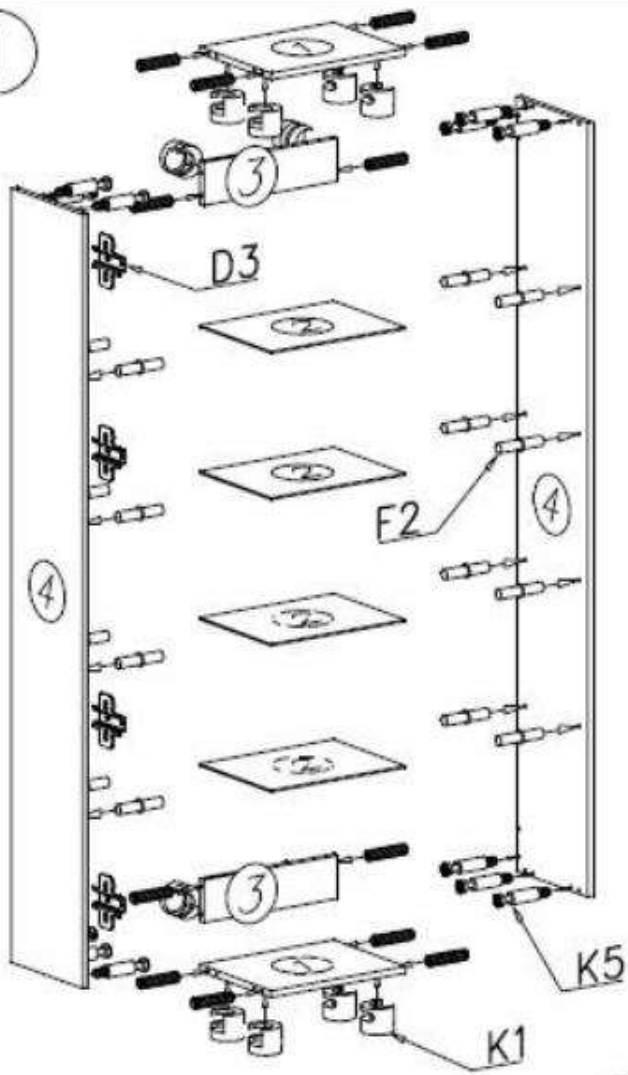

II

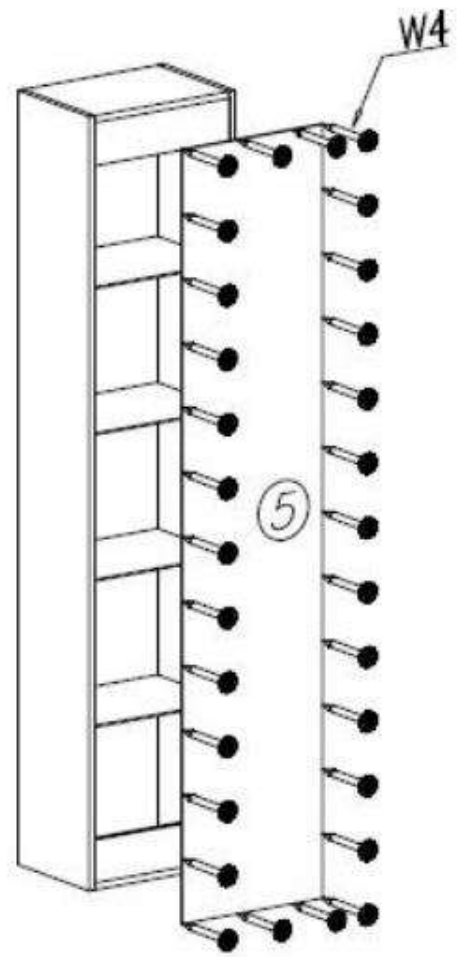

III

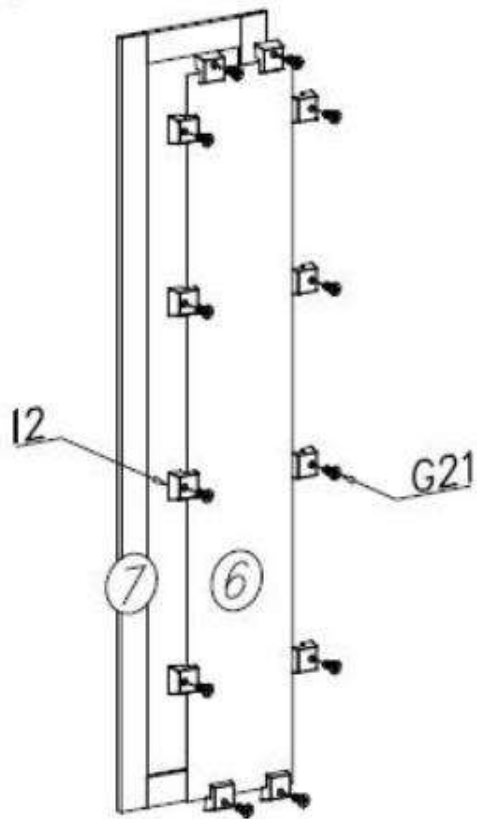

IV

