

VILGO

Typ J

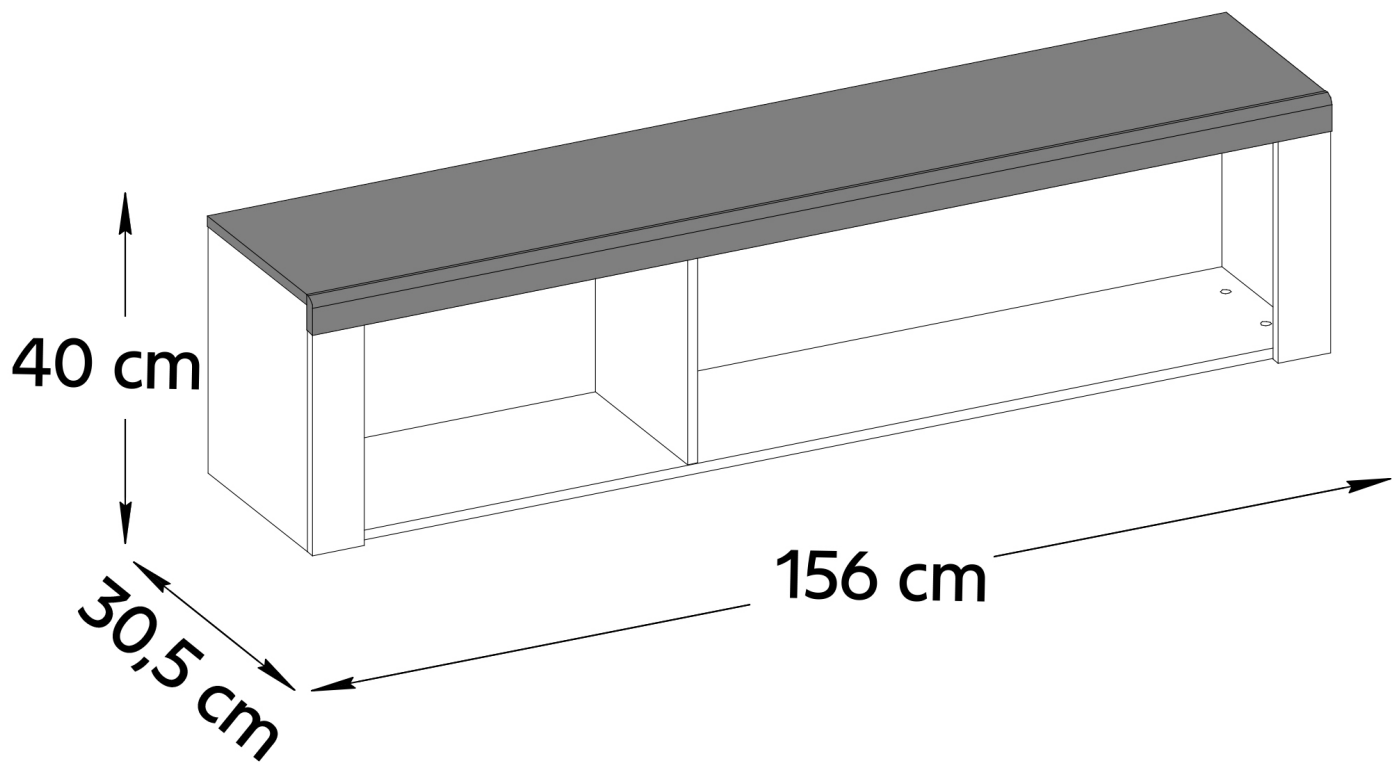

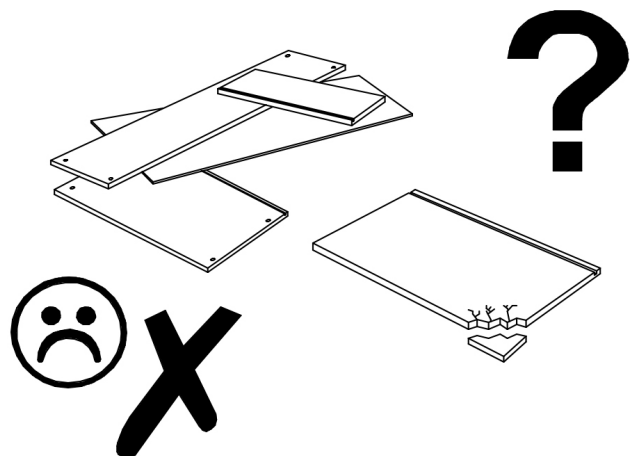

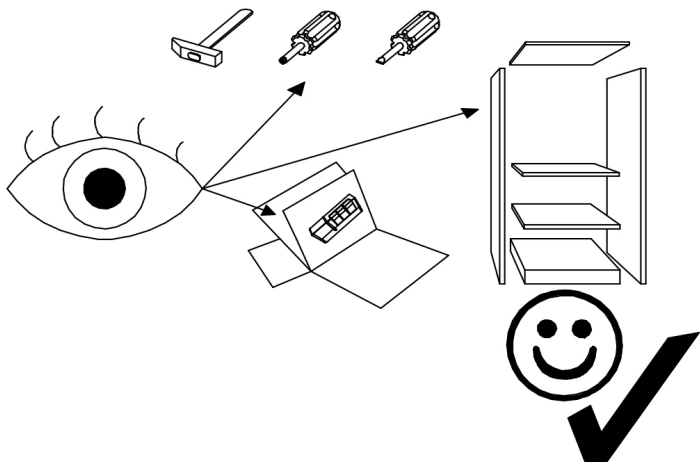
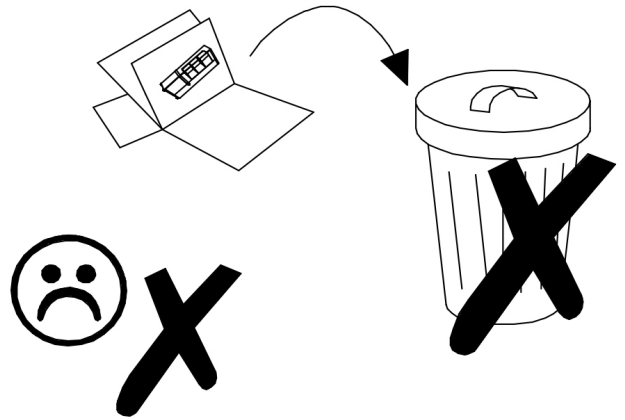
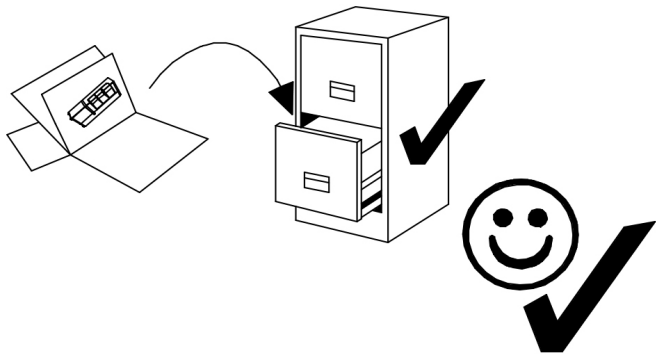
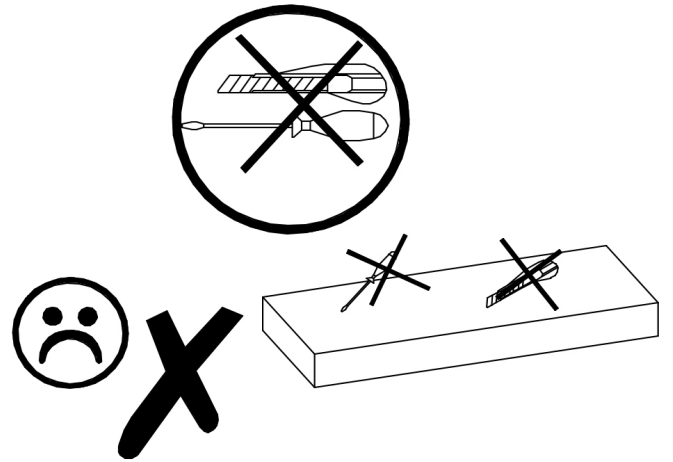
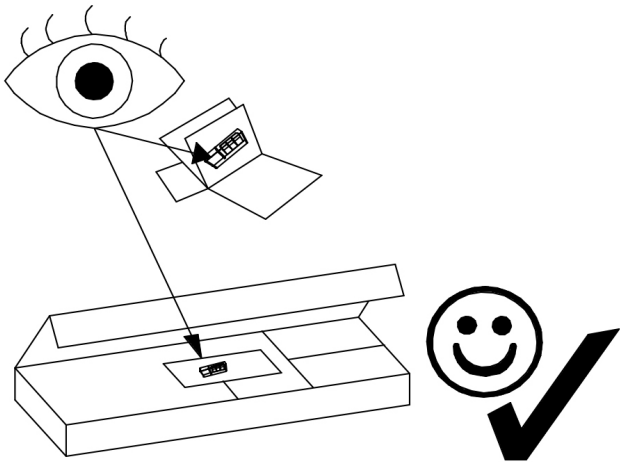
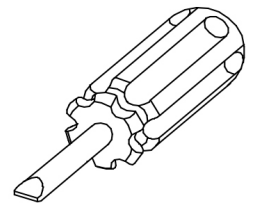
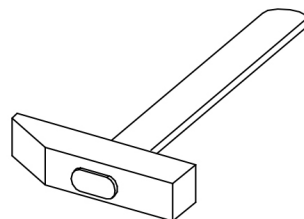
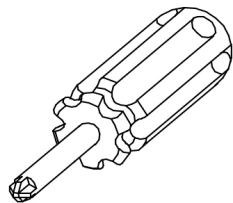
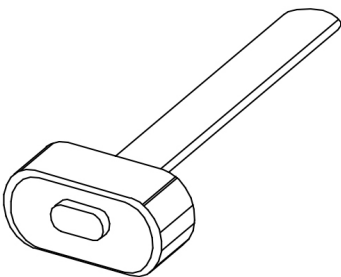
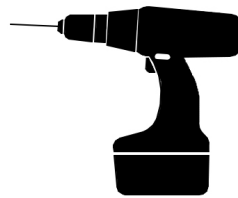
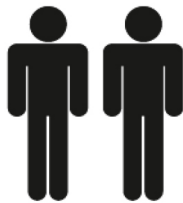
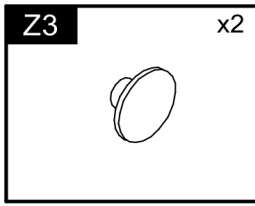
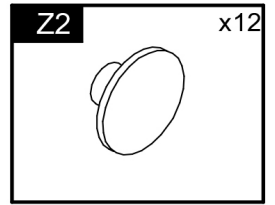
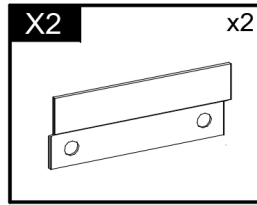
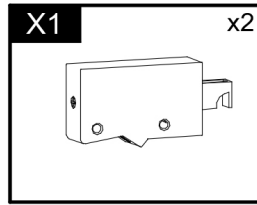
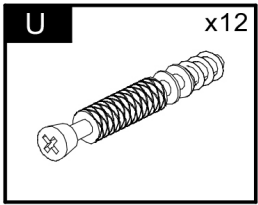
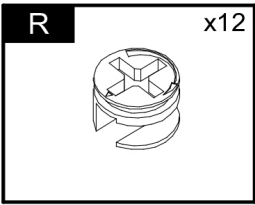
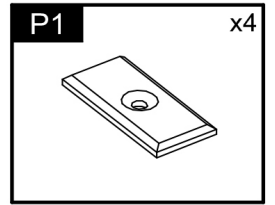
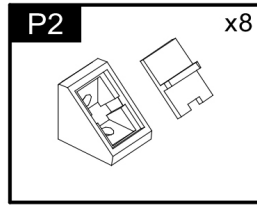
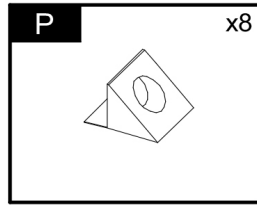
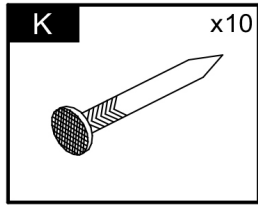
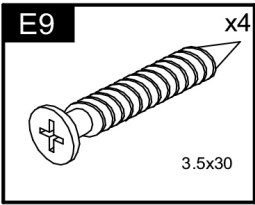
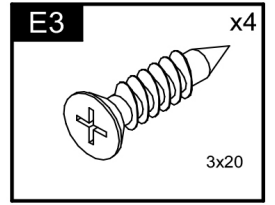
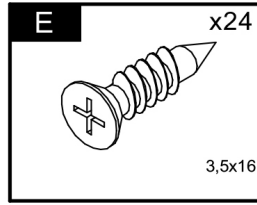
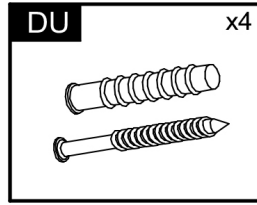
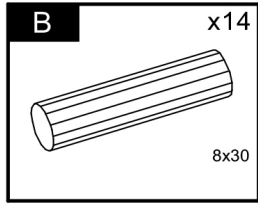
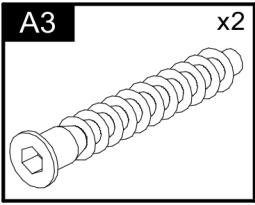
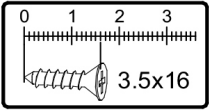
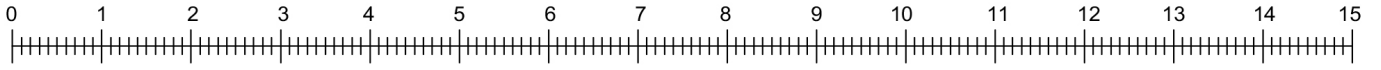

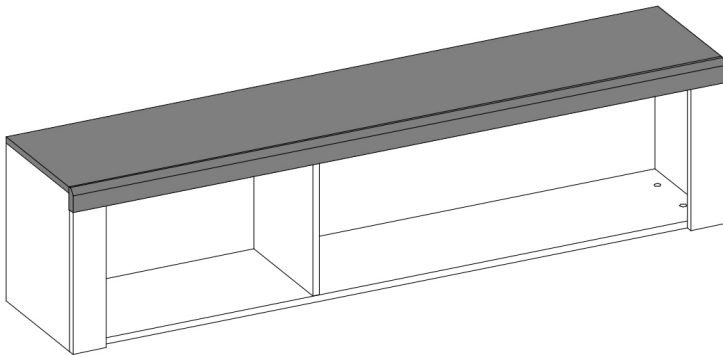

1	1560	303	16	1	1004	1/1
2	384.5	303	16	1	1002	1/1
3	384.5	303	16	1	1003	1/1
4	368	282	16	1	1038	1/1
5	1526	282	16	1	1039	1/1
6	581	391	3	1	1040_v	1/1
7	958	391	3	1	1041_v	1/1
8	347	82	16	1	1020/3001	1/1
9	347	82	16	1	1020/3002	1/1
10	1562	56	19	1	1009/3003	1/1

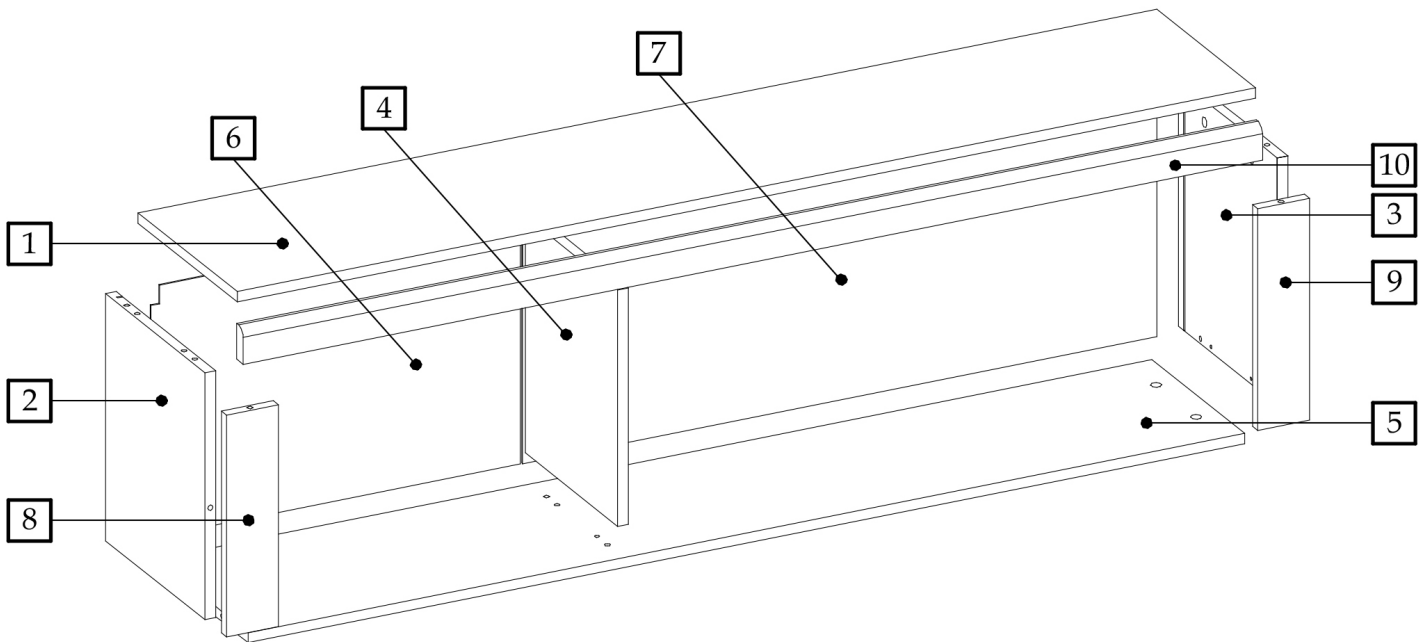

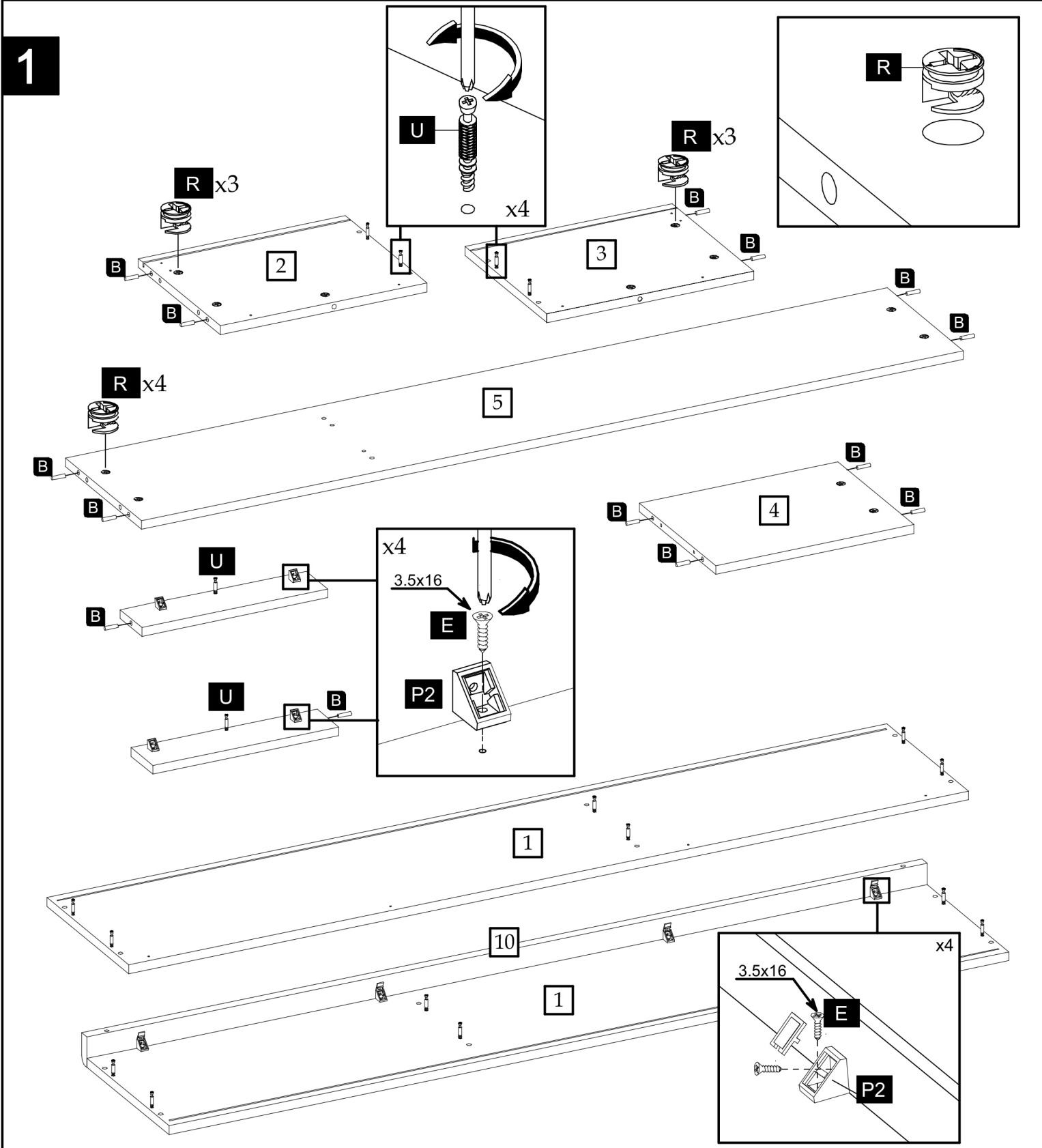
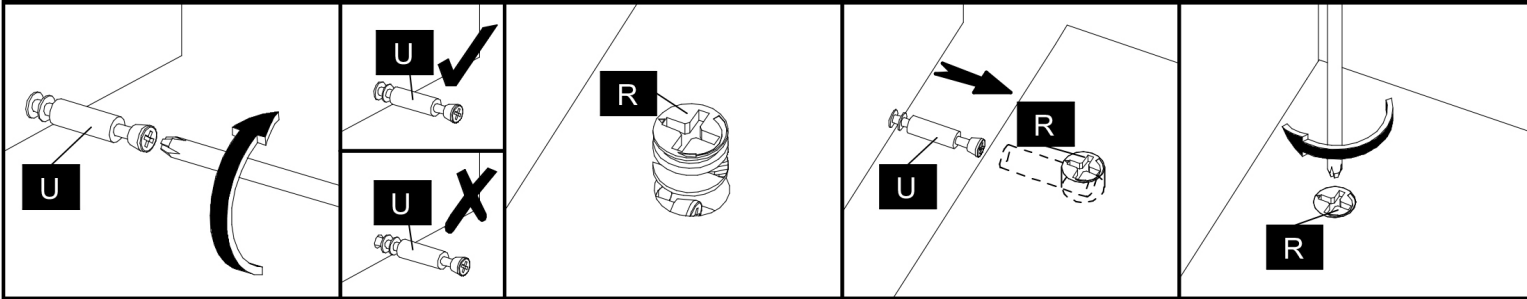

2

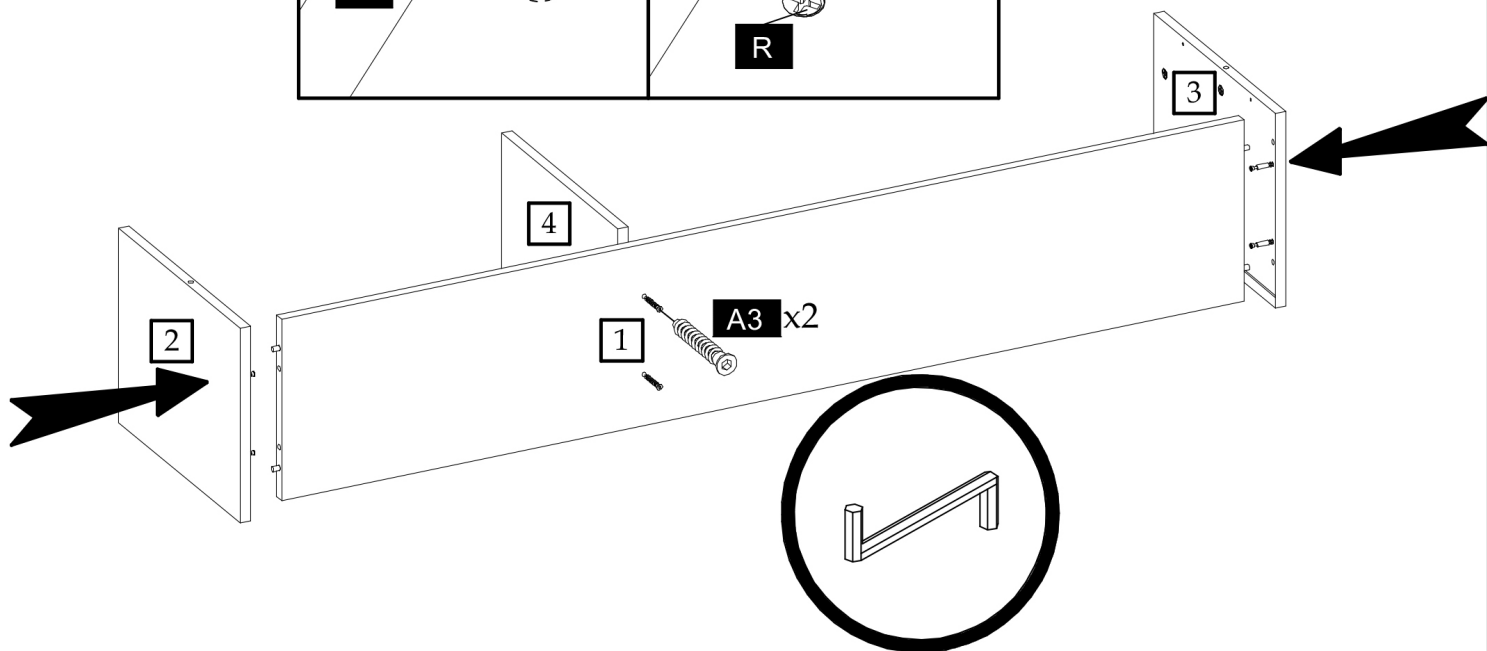
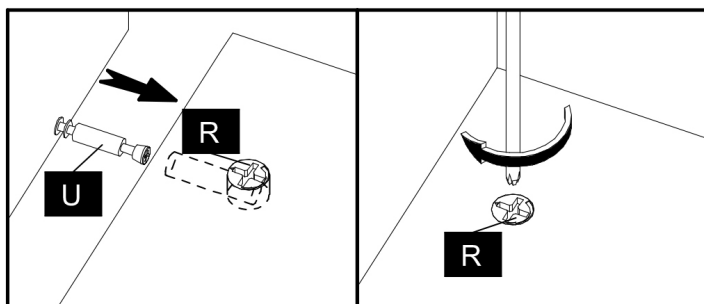

3

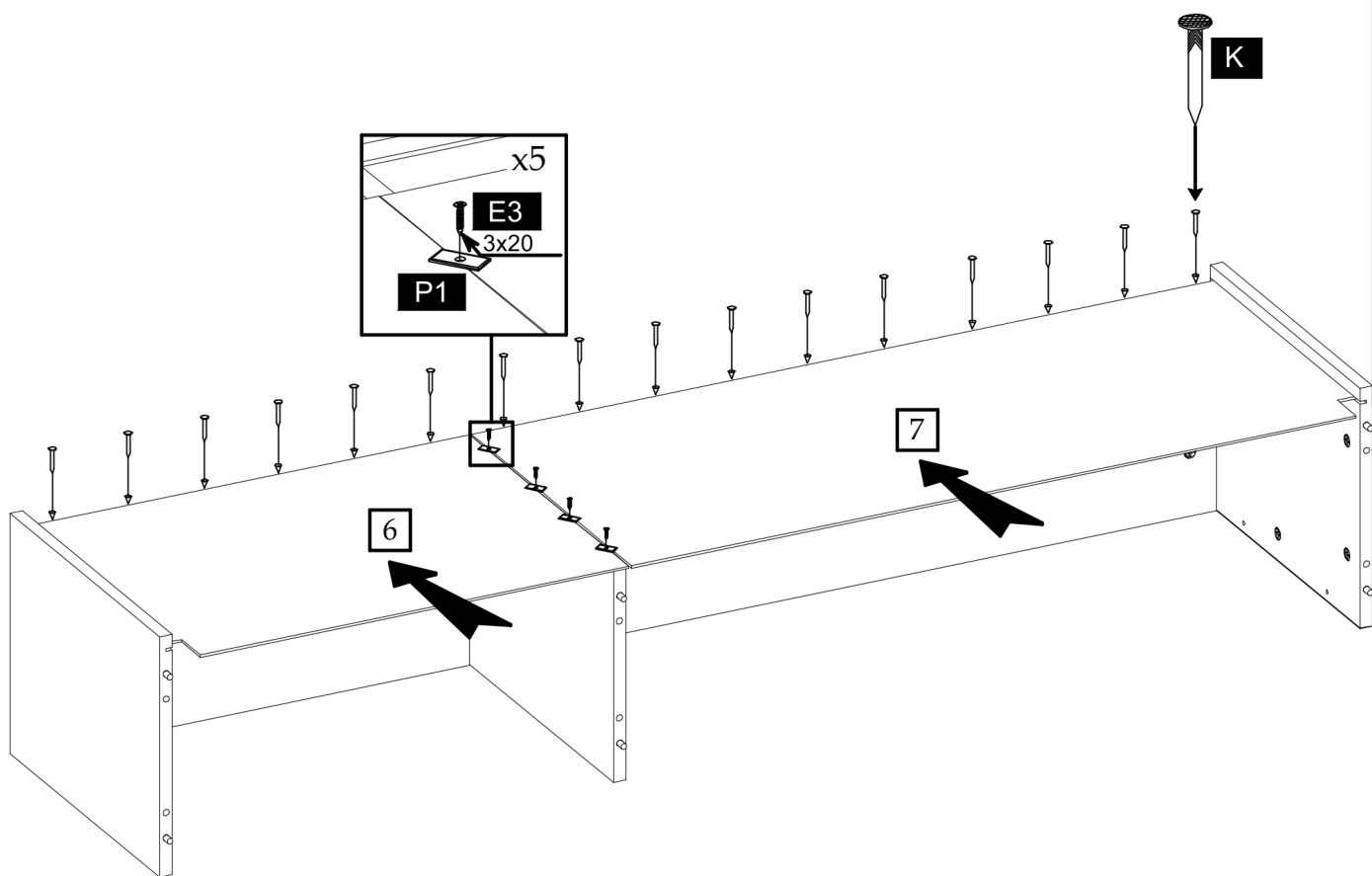

4

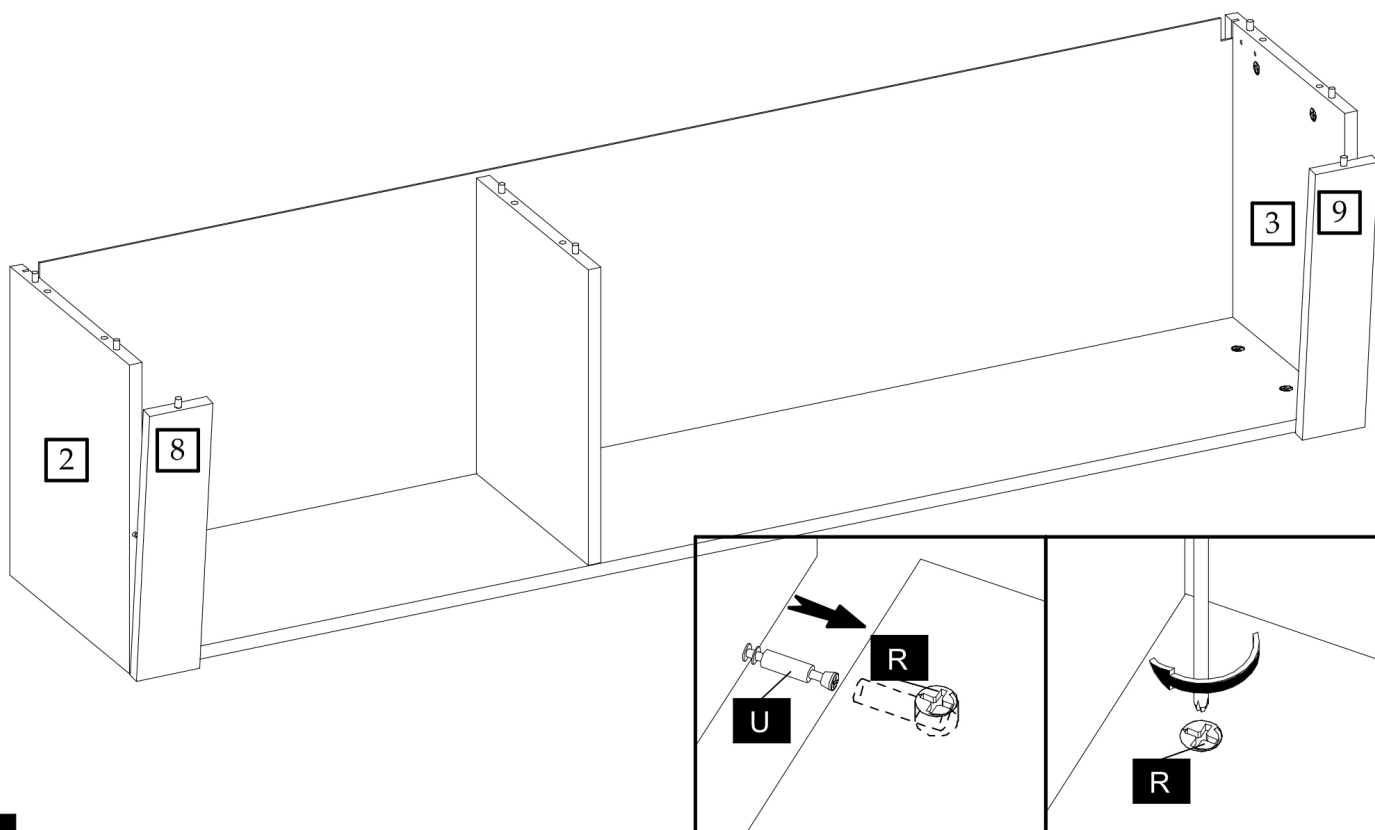

5

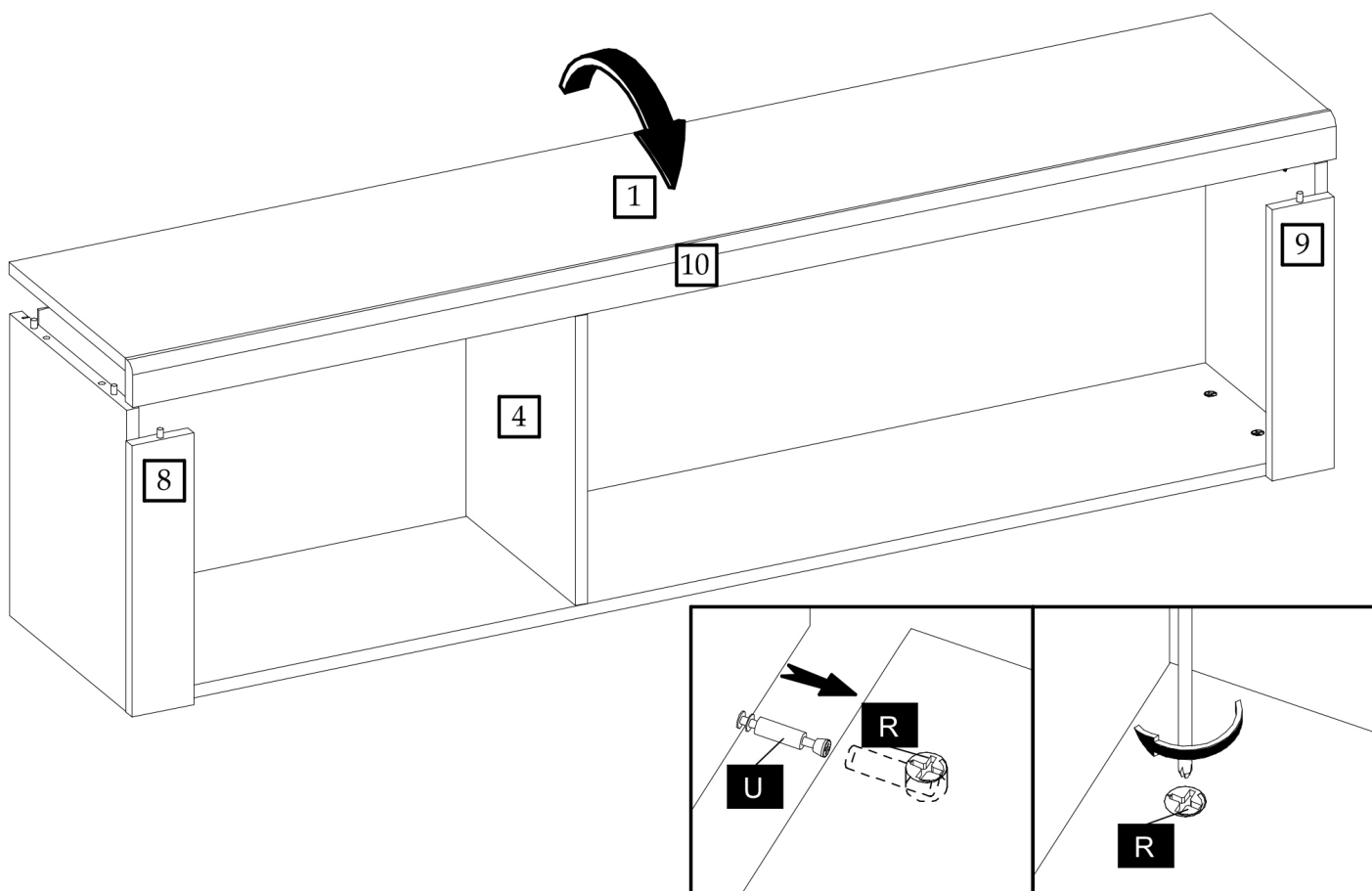

6

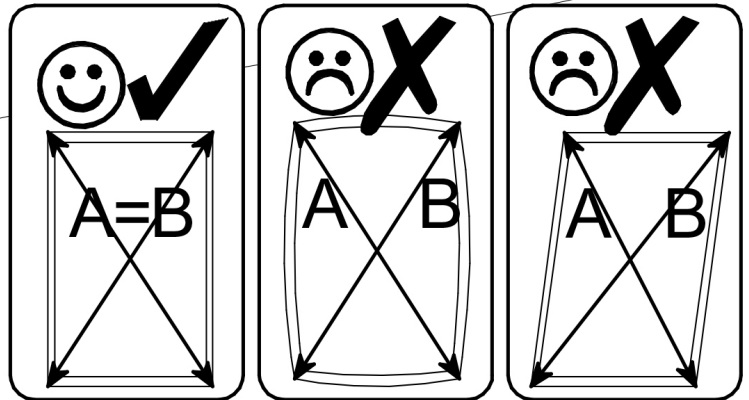
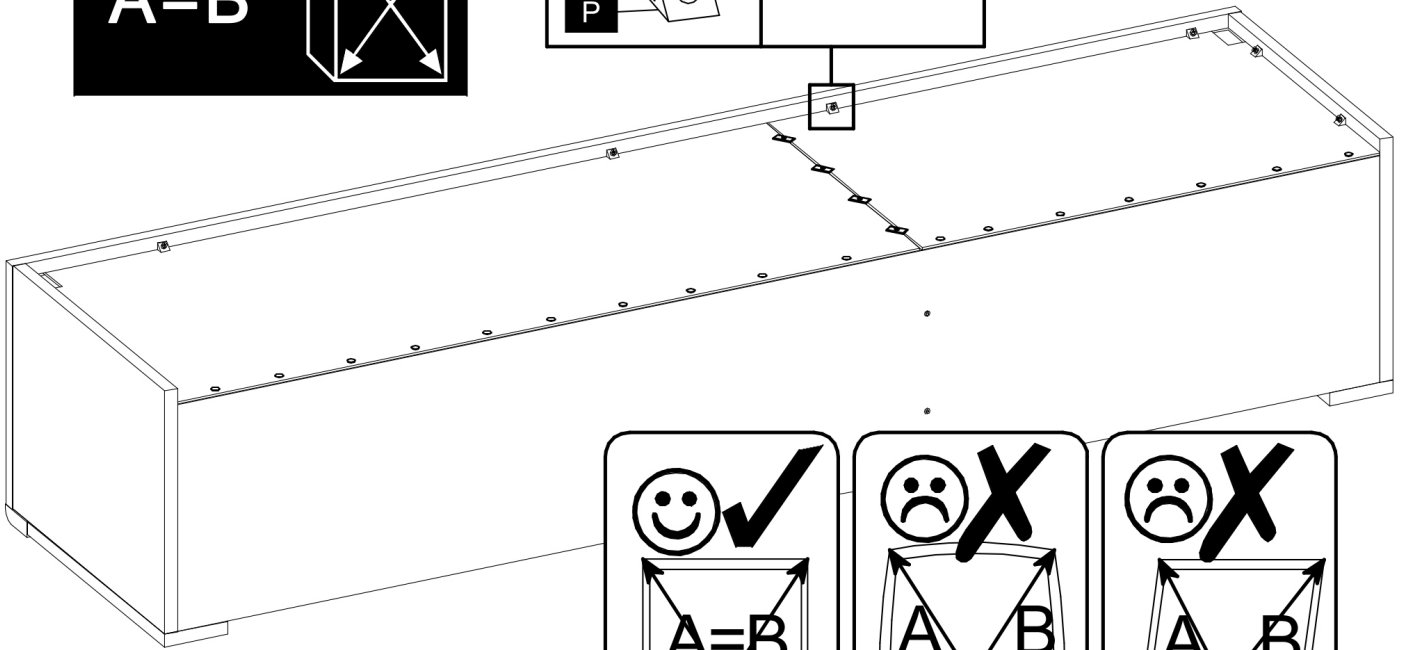
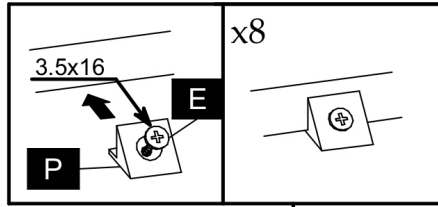
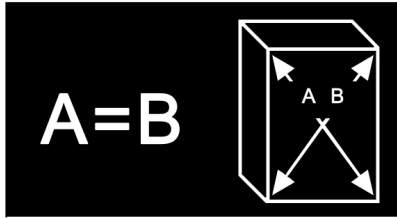

7

