

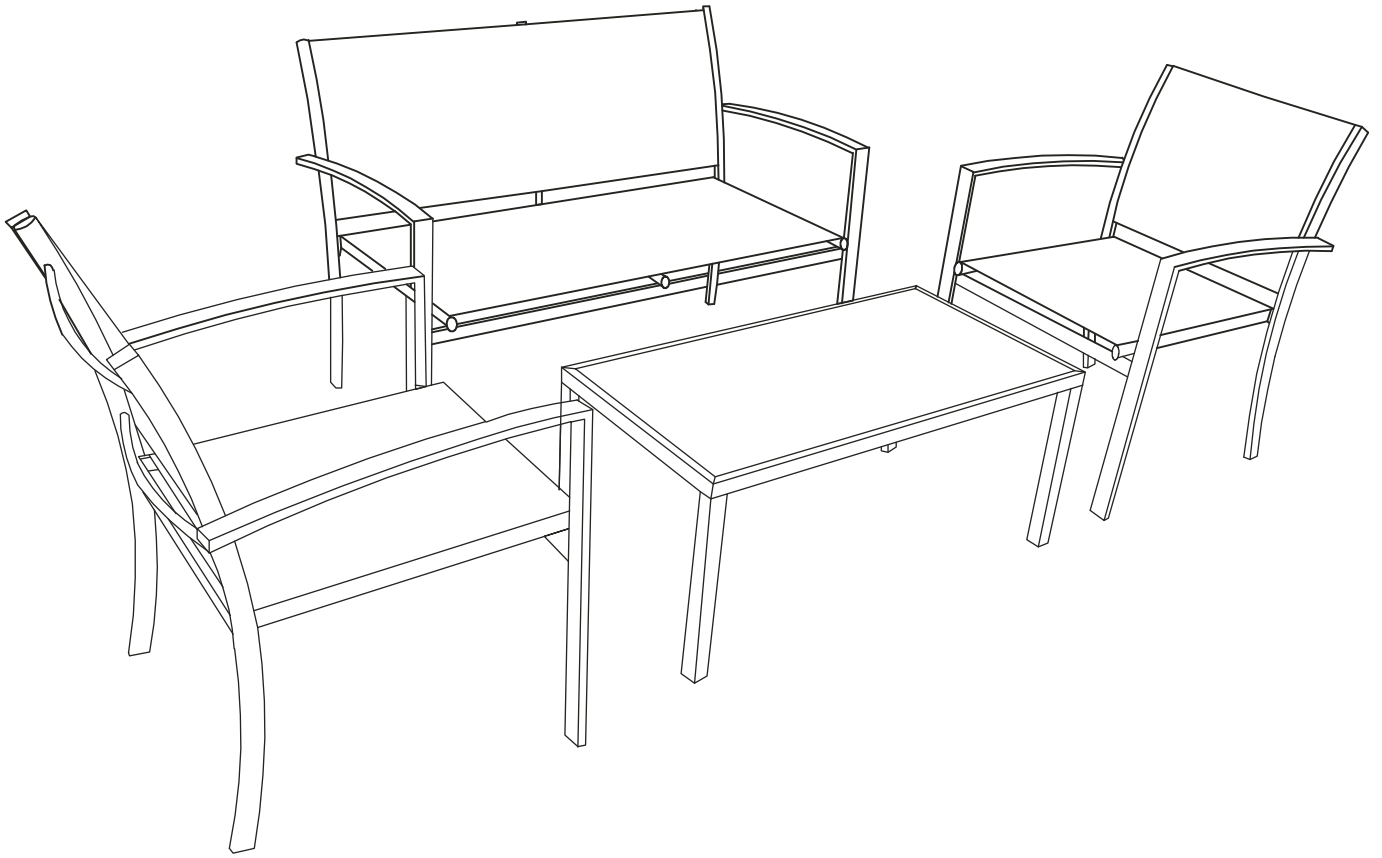

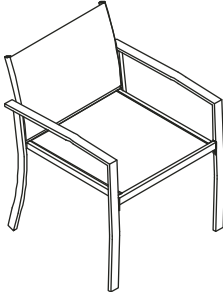

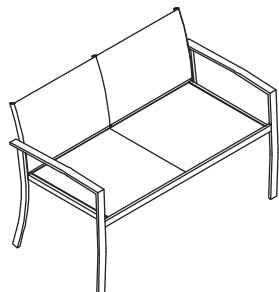







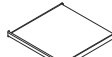
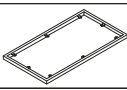



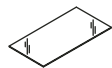

# DILAR

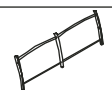

No.			
MP1			2
MP2			1
MP3			1

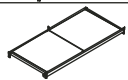
A		6	H		1	O	 $\phi 12 \times \phi 6.5 \times 1.0$	52
B		2	I		1	P		52
C		2	J		4	Q		12
D		3	K		1	R		12
E		3	L	 M6 x 15	22	S		1
F		1	M	 M6 x 25	12	T		1
G		1	N	 M6 x 50	18			

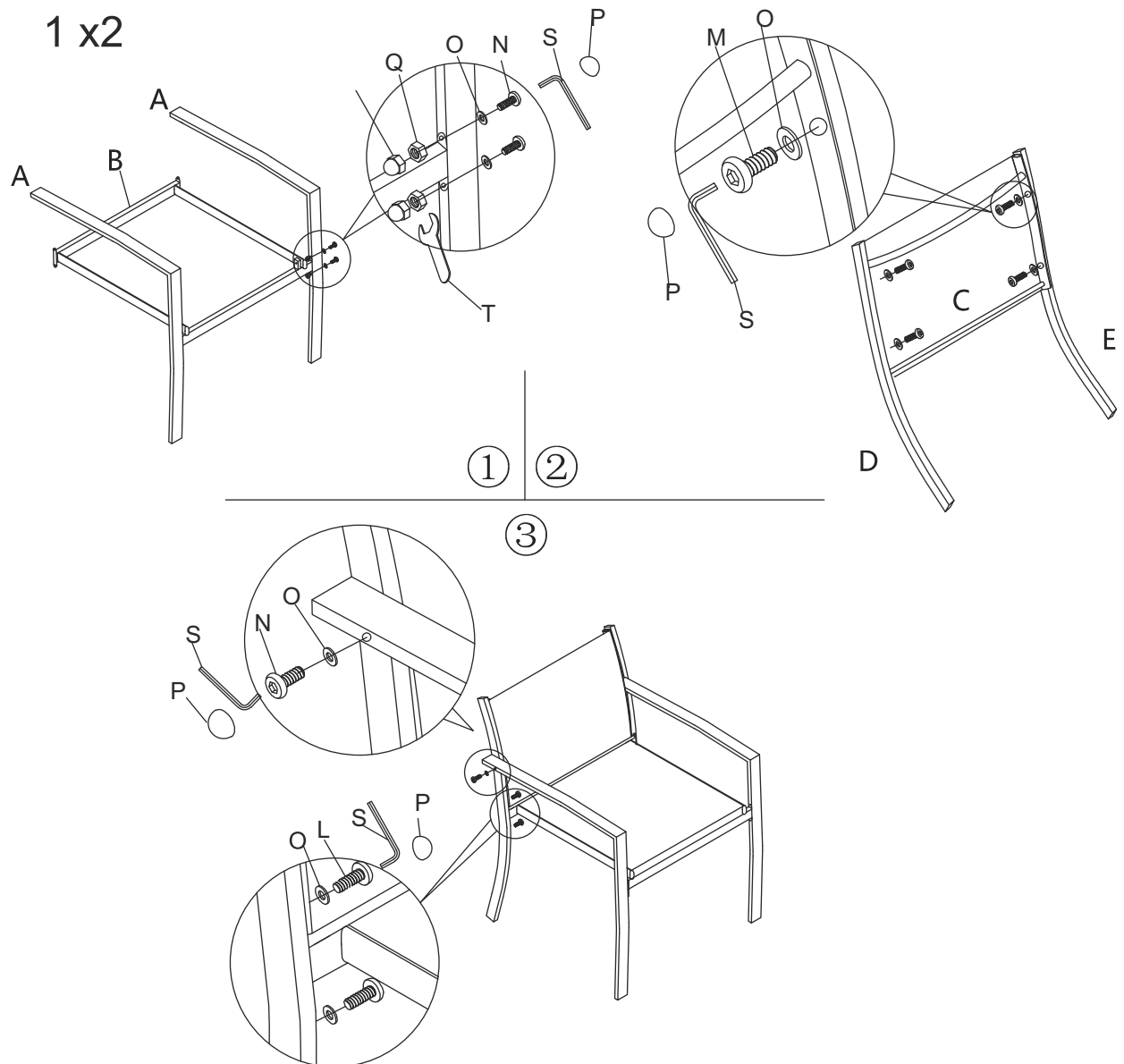

2

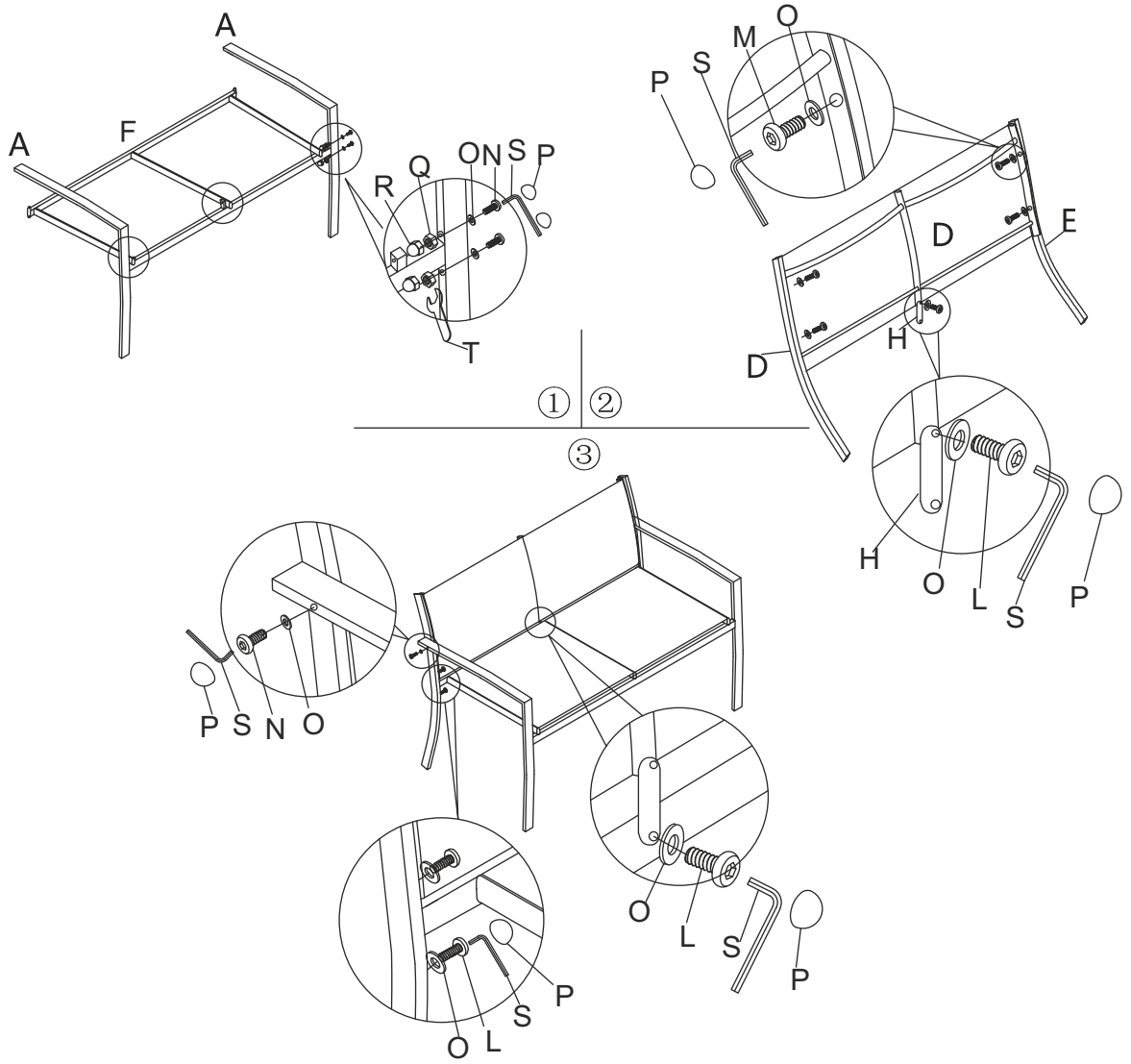

3

